

BRIDGE SINGLE SURFACE

D92110

PROJECT _____

TYPE _____

NOTES _____

QUANTITY _____

DATE _____

GENERAL

Series: Bridge
 Subseries: Bridge Single
 Brand: Milan
 Division: Design
 Mounting Type: Surface
 Mounting Location: Ceiling
 Subcategory: Spots

PHYSICAL

Shape: Rectangle
 Length (mm): 107
 Length (in): 4 ³/₁₆
 Width (mm): 110
 Width (in): 4 ³/₁₆
 Extension (mm): 156
 Extension (in): 6 ¹/₈
 Light Distribution: Adjustable / Direct
 Weight (kg): 1.4
 Weight (lbs): 3
 Fixture Finish: WHI
 Fixture Material: Aluminum

ELECTRICAL

Input Wattage Range: 10 - 19 W
 Lamp Type: LED
 Total Output Wattage (W): 9.7
 Dimming: Non-Dimming / Phase Dimming (120Vac only) / 0-10V Dimming
 Driver Included: Yes
 Driver Location: External
 Driver Type: Constant Current - 120 / 277Vac
 Driver Class: Class 2
 Input Voltage (V): 120 - 277
 Constant Current (mA): 350

LED

Number of LEDs: 1
 Color Temperature (°K): 3000
 Max. Delivered Lumen (lm): 1010
 CRI: >80 CRI
 Lamp Life (hrs): 50000

OPTICAL

Reflector°: 50

RATINGS AND CERTIFICATIONS

Certified By: CSA Certified to UL and CSA Standards
 IP rating: IP20

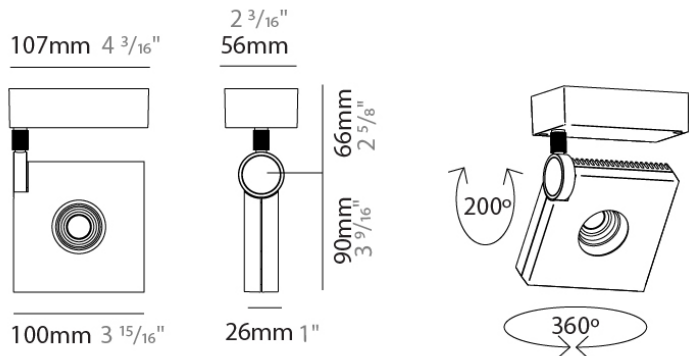

BRIDGE DOUBLE SURFACE

D92112

PROJECT	
TYPE	
NOTES	
QUANTITY	
DATE	

GENERAL

Series: Bridge
 Subseries: Bridge Double
 Brand: Milan
 Division: Design
 Mounting Type: Surface
 Mounting Location: Ceiling
 Subcategory: Spots

PHYSICAL

Shape: Rectangle
 Length (mm): 280
 Length (in): 11
 Width (mm): 110
 Width (in): 4 3/16
 Extension (mm): 156
 Extension (in): 6 1/8
 Light Distribution: Adjustable / Direct
 Weight (kg): 3.62
 Weight (lbs): 8
 Fixture Finish: WHI
 Fixture Material: Aluminum

ELECTRICAL

Input Wattage Range: 20 - 29 W
 Number of Lamps: 2
 Lamp Type: LED
 Total Output Wattage (W): 20
 Dimming: Tri-Mode (Non-Dimming and Phase Dimming (120Vac only) and 0-10V Dimming)
 Driver Included: Yes
 Driver Location: Integrated
 Driver Type: Constant Current - Universal
 Driver Class: Class 2
 Input Voltage (V): 120 - 277
 Constant Current (MA): 700

LED

Number of LEDs: 2
 Color Temperature (°K): 3000
 Max. Delivered Lumen (lm): 2020
 CRI: >80 CRI
 Lamp Life (hrs): 50000

OPTICAL

Reflector°: 50

RATINGS AND CERTIFICATIONS

Certified By: CSA Certified to UL and CSA Standards
 IP rating: IP20

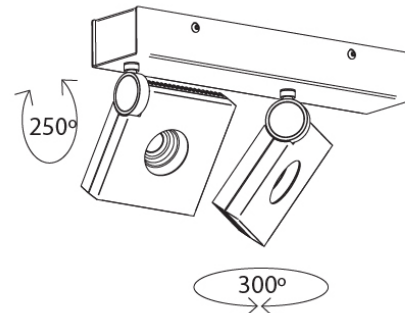
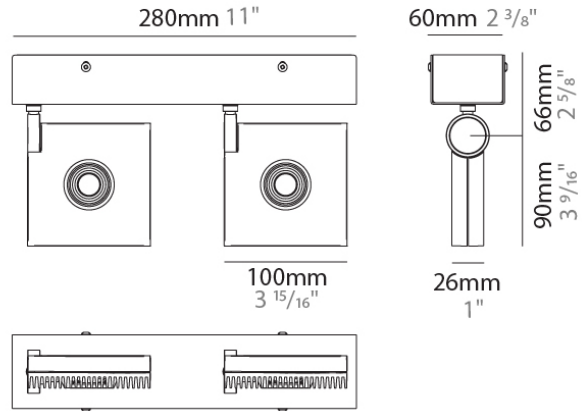

BRIDGE SINGLE RECESSED

D92117

PROJECT	_____
TYPE	_____
NOTES	_____
QUANTITY	_____
DATE	_____

GENERAL

Series: Bridge
Subseries: Bridge Single
Brand: Milan
Division: Design
Mounting Type: Recessed
Mounting Location: Ceiling
Subcategory: Downlight

PHYSICAL

Shape: Round
Diameter (mm): 120
Diameter (in): 4 3/4
Height (mm): 40
Height (in): 1 9/16
Light Distribution: Adjustable / Direct
Weight (kg): 0.5
Weight (lbs): 1.2
Fixture Finish: WHI
Fixture Material: Aluminum

ELECTRICAL

Number of Lamps: 1
Lamp Type: LED
Max. Wattage Per Lamp (W): 10
Dimming: Non-Dimmable
Driver Included: Yes
Driver Location: External
Driver Type: Constant Current
Driver Class: Class 2
Input Voltage (V): 120
Constant Current (mA): 350
Upon Request: Dimming option available upon request

LED

Number of LEDs: 1
Color Temperature (°K): 3000
Max. Delivered Lumen (lm): 1010
CRI: >80 CRI
Lamp Life (hrs): 50000

OPTICAL

Reflector°: 50

RATINGS AND CERTIFICATIONS

Certified By: CSA Certified to UL and CSA Standards
IP rating: IP20

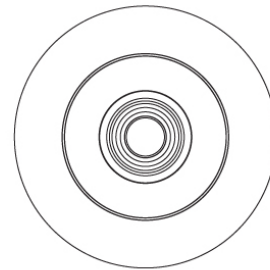

Ø120mm 4 3/4"

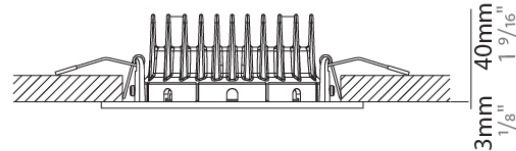

BRIDGE SINGLE SURFACE

D92118

PROJECT	
TYPE	
NOTES	
QUANTITY	
DATE	

GENERAL

Series: Bridge
Subseries: Bridge Single
Brand: Milan
Division: Design
Mounting Type: Surface
Mounting Location: Ceiling
Subcategory: Spots

PHYSICAL

Shape: Square
Length (mm): 130
Length (in): 5 1/8"
Width (mm): 130
Width (in): 5 1/8"
Height (mm): 127
Height (in): 5"
Light Distribution: Adjustable / Direct
Weight (kg): 1.8
Weight (lbs): 4
Fixture Finish: WHI
Fixture Material: Aluminum

ELECTRICAL

Number of Lamps: 1
Lamp Type: LED
Max. Wattage Per Lamp (W): 10
Dimming: Non-Dimmable
Driver Included: Yes
Driver Location: Integrated
Driver Type: Constant Current
Driver Class: Class 2
Input Voltage (V): 120
Constant Current (MA): 350
Upon Request: Dimmable option available with remote driver upon request

LED

Number of LEDs: 1
Color Temperature (°K): 2700
Max. Delivered Lumen (lm): 1010
CRI: >80 CRI

OPTICAL

Reflector°: 50

RATINGS AND CERTIFICATIONS

Certified By: CSA Certified to UL and CSA Standards
IP rating: IP20

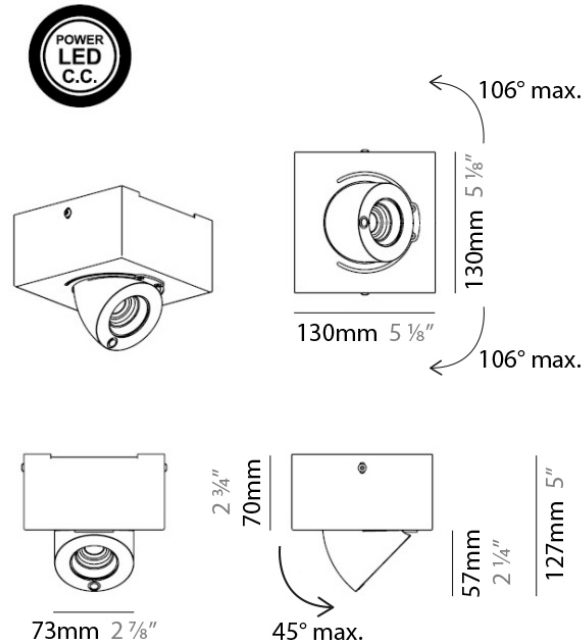

BRIDGE DOUBLE SURFACE

D92119

PROJECT	
TYPE	
NOTES	
QUANTITY	
DATE	

GENERAL

Series: Bridge
 Subseries: Bridge Double
 Brand: Milan
 Division: Design
 Mounting Type: Surface
 Mounting Location: Ceiling
 Subcategory: Spots

PHYSICAL

Shape: Rectangle
 Length (mm): 300
 Length (in): 11 ¹³/₁₆"
 Width (mm): 160
 Width (in): 6 ⁵/₁₆"
 Height (mm): 127
 Height (in): 5
 Light Distribution: Adjustable / Direct
 Weight (kg): 4.1
 Weight (lbs): 9
 Fixture Finish: WHI
 Fixture Material: Aluminum

ELECTRICAL

Number of Lamps: 2
 Lamp Type: LED
 Total Output Wattage (W): 20
 Max. Wattage Per Lamp (W): 10
 Dimming: Non-Dimmable
 Driver Included: Yes
 Driver Location: Integrated
 Driver Type: Constant Current
 Driver Class: Class 2
 Input Voltage (V): 120 - 277
 Constant Current (MA): 700
 Upon Request: Dimmable option available with remote driver upon request

LED

Number of LEDs: 2
 Color Temperature (°K): 2700
 Max. Delivered Lumen (lm): 2020
 CRI: >80 CRI

OPTICAL







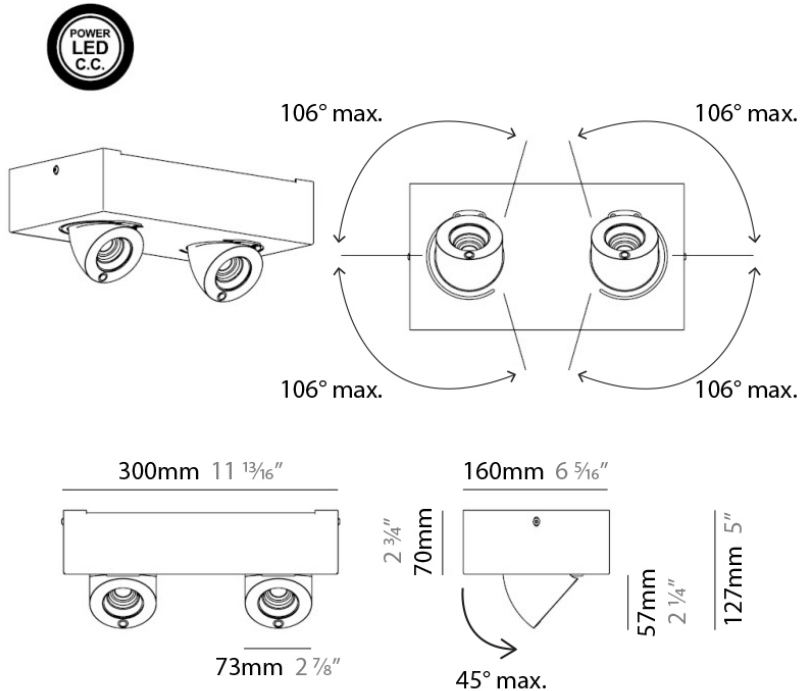





























































Reflector°: 50

RATINGS AND CERTIFICATIONS

Certified By: CSA Certified to UL and CSA Standards
 IP rating: IP20













LEGEND

	floor-mounted		pivotal		special LED (upon request) RGB, RGBW, tunable, gold+, meat+, art+, fashion+
	wall and ceiling: recessed and surface mounted		rotating		warm dim / natural dimming LED
	ceiling-mounted and wall-mounted		illuminate tilted		rechargeable battery powered
	wall-mounted		color of suspension cable		fixture with natural vivid LED (upon request)
	omni-directional light distribution		length of suspension cable		color rendering index
	direct light distribution		reflector degree selection		color temperature
	direct/indirect light distribution		super spot		lumen (luminous flux)
	indirect light distribution		lens		efficacy (lumens per watt)
	asymmetric light distribution		lens pack		Unified Glare Rating (UGR) range from 5-40
	aura light distribution		shine ring		marine grade (AISI 316 stainless steel)
	round wall or ceiling cut-out		integrated shine ring with diffuser		walk on
	square wall or ceiling cut-out		free individual colors 01-29		drive on
	the supplied jig specifies the cutout dimensions		individual colors: 00 (free of charge), 01-25 (extra charge)		Dark Sky Compliance
	minimum distance (meters) lamp - object		luminaire part to be colored (F1)		Americans with Disabilities Act (less than 4" off the wall located between 27"-84" from floor)
	recessed depth		luminaire part to be colored (F2)		lamp protected against explosion
	ceiling thickness in mm		luminaire part to be colored (F3)		blown glass using traditional methods by master glass blower
	ceiling thickness selection		luminaire part to be colored (F4)		acoustic material
	dimmable DP (phase), DV (0-10V), DD (dali), DS (step-dim)		luminaire part to be colored (F5)		protection class I, protection insulation
	included or excluded LED driver/transformer/control gear		color of 3-circuit adaptor		protection class II, protection insulation
	separately switchable		indirect diffuser		ETL Certified to UL and CSA Standards
	sensor		direct diffuser		UL Certified to UL and CSA Standards
	remote control		ball-proof (upon request)		CSA Certified to UL and CSA Standards
	available upon request		accessory		Certified for North American Standards

IP RATING

	protected against ingress of solid bodies greater than 12.5mm (finger)
	protected against ingress of solid bodies greater than 2.5mm protected against sprays of water up to 60 degrees from the vertical (rain)
	protected against ingress of solid bodies greater than 1mm (wire) no protection against the ingress of moisture
	protected against ingress of solid bodies greater than 1mm (wire) protected against sprays of water up to 60 degrees from the vertical (rain)
	protected against ingress of solid bodies greater than 1mm (wire) protected against water splashed from all directions
	protected against limited ingress of dust (wet rooms/covered outdoor areas) protected against water splashed from all directions
	protected against ingress of dust protected against jets of water
	protected against ingress of dust protected against powerful jets of water or heavy seas
	protected against ingress of dust protected against immersion of water between 15cm - 1m for 30 minutes
	protected against ingress of dust protected against immersion of water under pressure for long periods

IK RATING

	protected against 0.14 joules impact (equivalent to 0.25kg mass dropped from 56mm above the surface)
	protected against 0.2 joules impact (equivalent to 0.25kg mass dropped from 80mm above the surface)
	protected against 0.35 joules impact (equivalent to 0.25kg mass dropped from 140mm above the surface)
	protected against 0.5 joules impact (equivalent to 0.25kg mass dropped from 200mm above the surface)
	protected against 0.7 joules impact (equivalent to 0.25kg mass dropped from 280mm above the surface)
	protected against 1 joules impact (equivalent to 0.25kg mass dropped from 400mm above the surface)
	protected against 2 joules impact (equivalent to 0.5kg mass dropped from 400mm above the surface)
	protected against 5 joules impact (equivalent to 1.7kg mass dropped from 300mm above the surface)
	protected against 10 joules impact (equivalent to 5.0kg mass dropped from 200mm above the surface)
	protected against 20 joules impact (equivalent to 5.0kg mass dropped from 400mm above the surface)